

A
SIZE

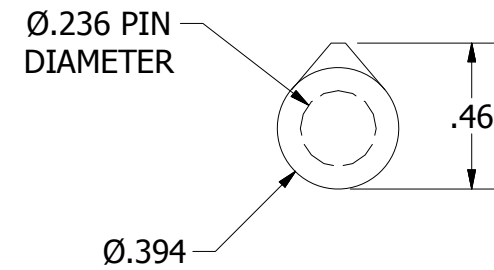

PART NUMBER: MH03-1003		SCALE: NTS
LEAF MATERIAL: STEEL	PIN MATERIAL: STEEL	FINISH: MILL
STANDARD TOLERANCES UNLESS OTHERWISE SPECIFIED (ALL TOLERANCES ARE NON-CUMULATIVE)		
.X ± .060	.XXX ± .015	FRACTIONAL: 1/16
.XX ± .030	.XXXX ± .005	ANGULAR: 1°

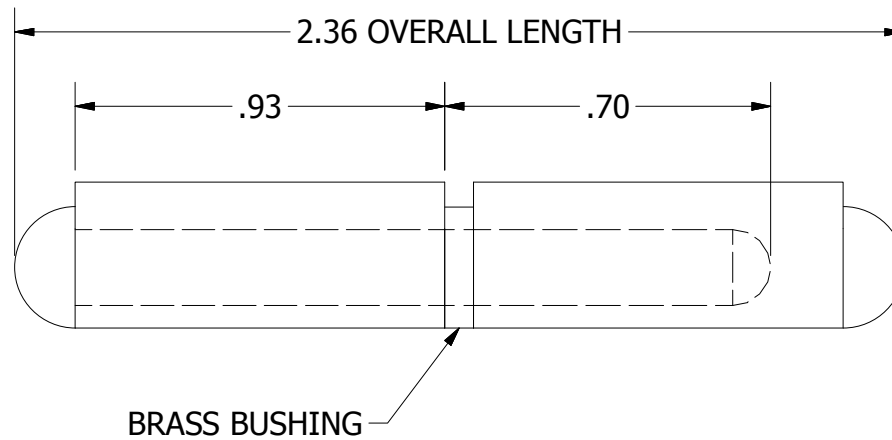
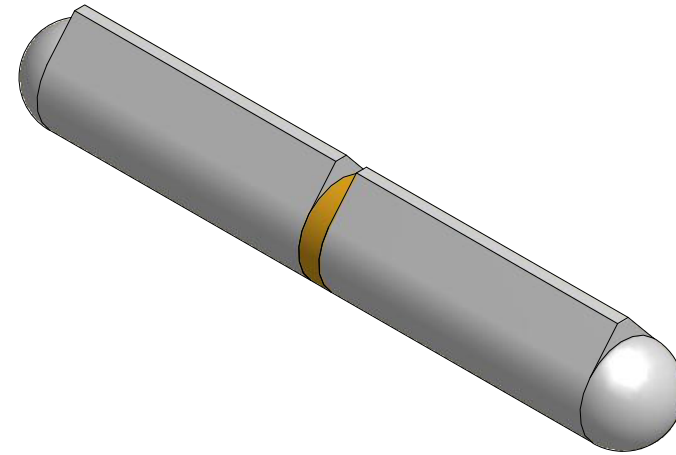
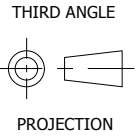

2822 Sable Mill Road
Jeffersonville IN, 47130 U.S.A.
www.1stSourceHardware.com
Sales@1stSourceProducts.com
Tel: 877-338-9403 | Fax: 812-288-7971